

BASE CABINET ASSEMBLY INSTRUCTION

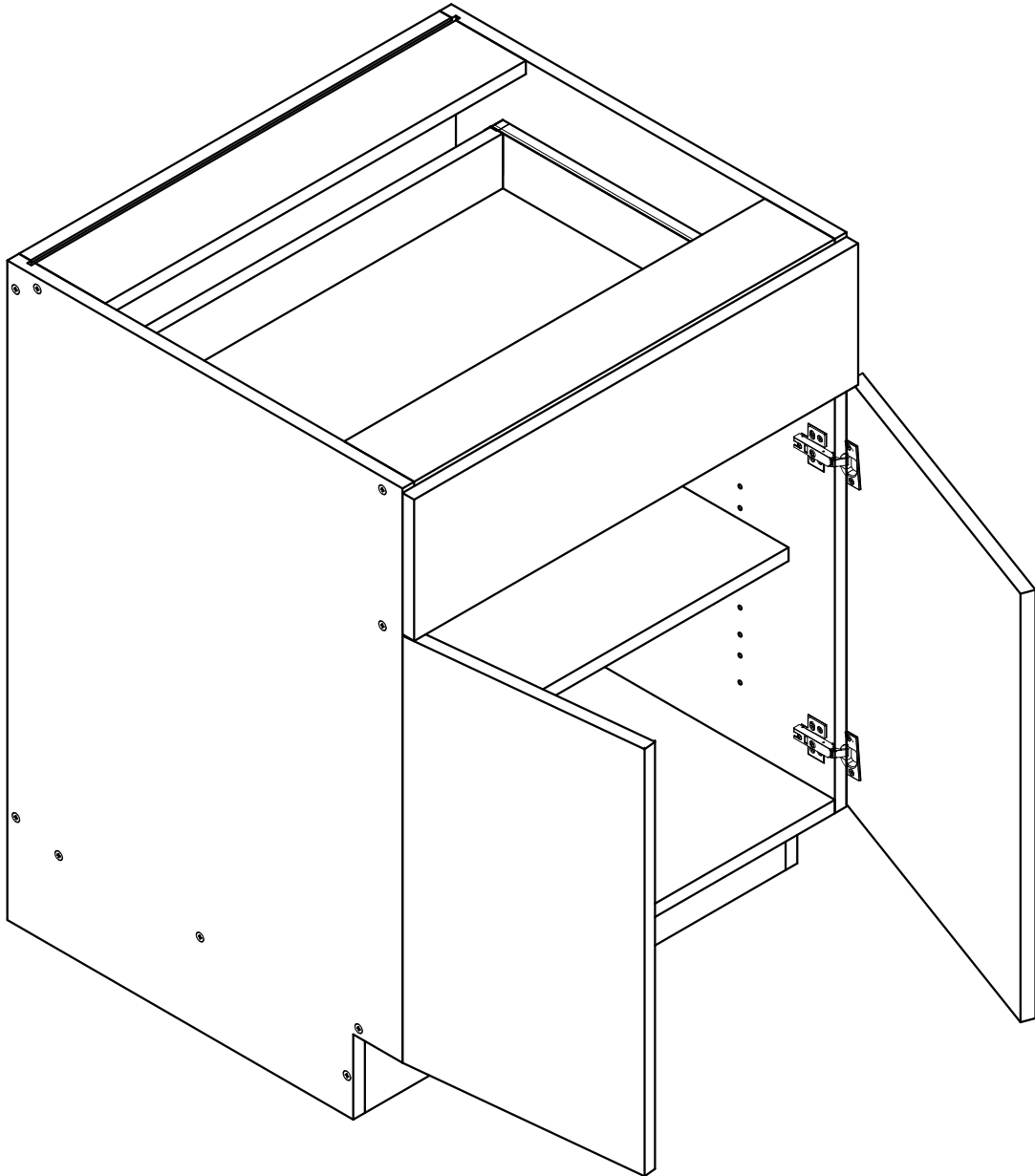

B24	B27
B30	B33
B36	

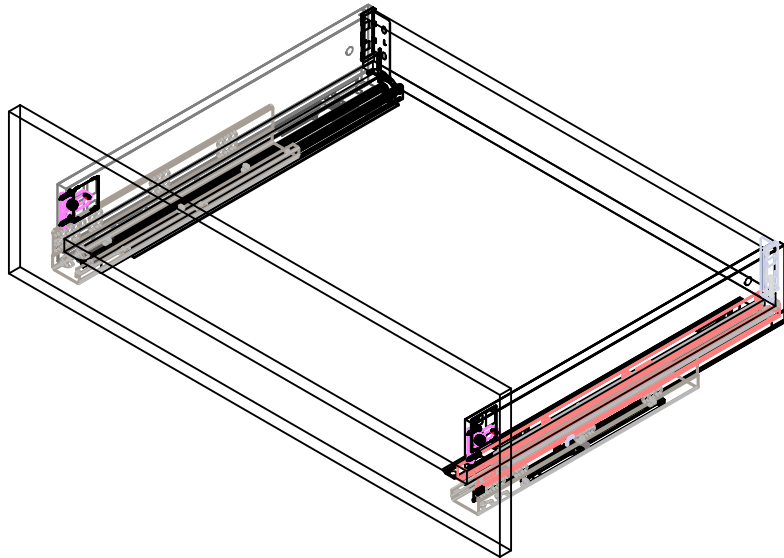

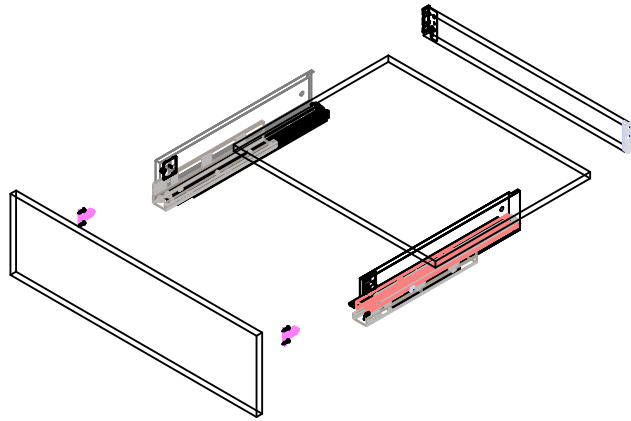
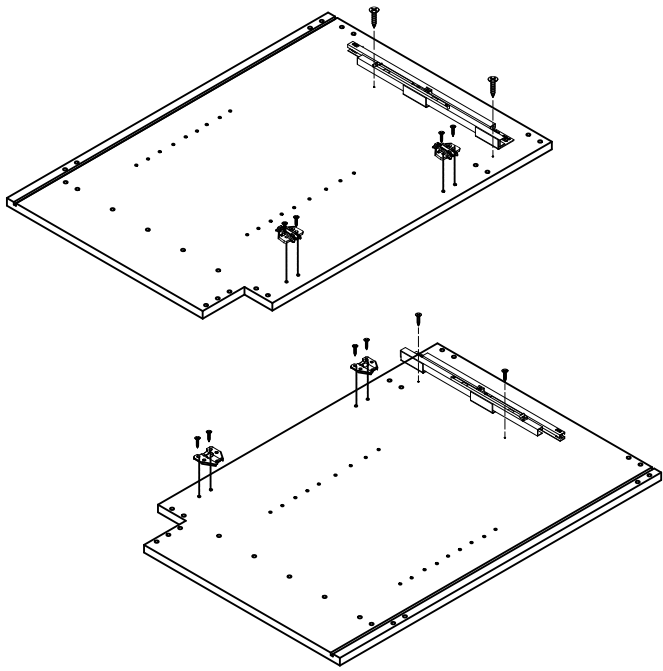

Step-1

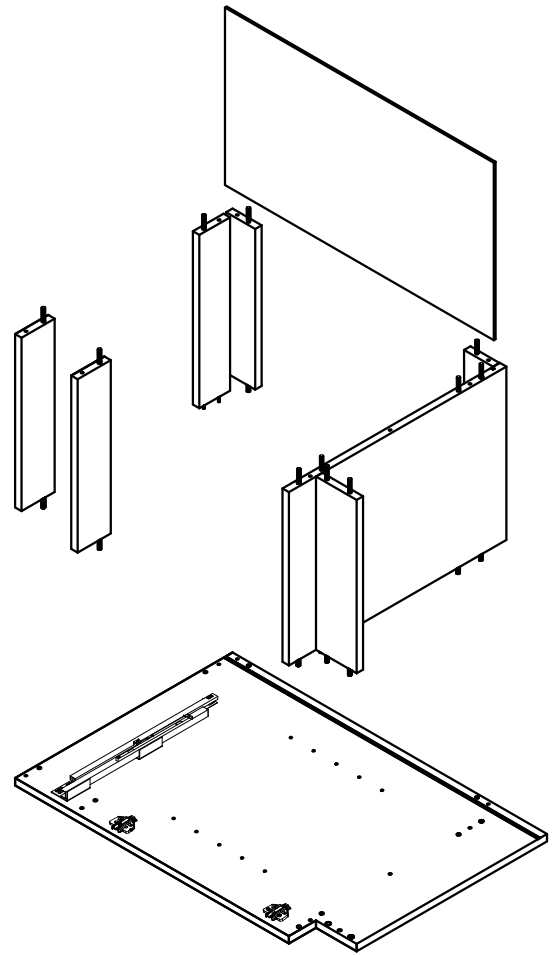

Step-2

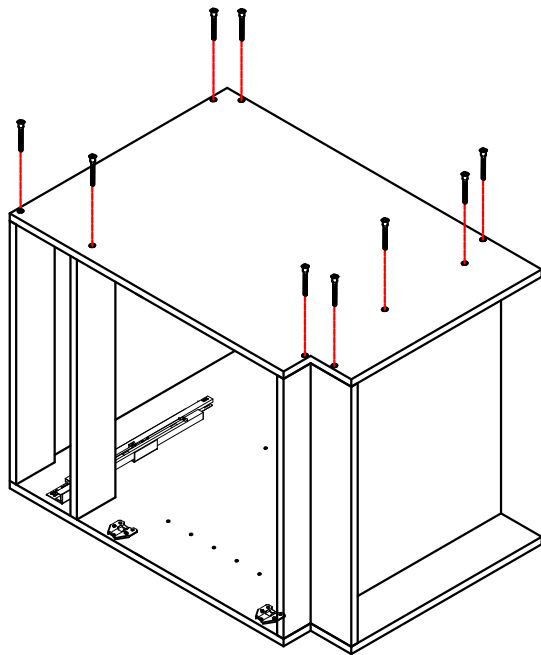

The other side panel is also assembled with screws

Step-3

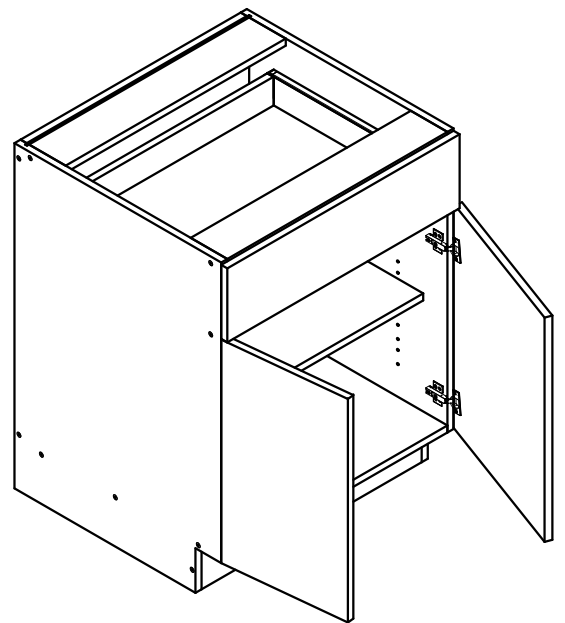

Step-4