

VKD36

ASSEMBLY INSTRUCTIONS

Getting started:

prepare a protection layer, a screwdriver

STEP 1: Joint side panel with back panel

STEP 2: Joint side panel with back panel

STEP 3: Attach frame on and toekick board

STEP 4: Attach the plastic block on the top corner





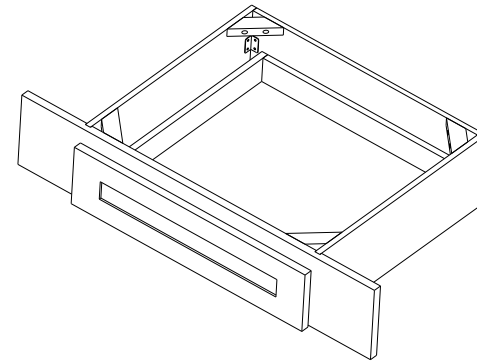

STEP 5: Joint the drawer together, then install the drawer guide.

STEP 6: Fix drawer head on the drawer front and adjust the cover-space

PARTS LIST		
NO.	Description	QTY
A	SIDE PANEL	2
B	BACK PANEL	1
C	FACE FRAME	1
D	DRAWER HEAD	1
E	DRAWER BOX BOTTOM	1
F	DRAWER BOX FRONT AND BACK	2
G	DRAWER BOX SIDE	2

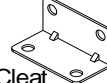

H

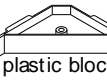
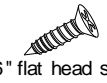
7	BUMPER	4	 Bumper
6	1" ROUND HEAD SCREW	4	 1" round head screw
5	Epoxy Slide	1	 Epoxy slider
4	9/16" ROUND HEAD SCREW	16	 9/16" round head screw
3	CLEAT	4	 Cleat
2	1" FLAT HEAD SCREW FOR CARCASS	8	 1" flat head screw
2	Plastic Block	4	 plastic block
1	9/16" flat head screw	18	 9/16" flat head screw
NO.	Description	QTY	PICTURE

HARDWARE LIST

STEP:1

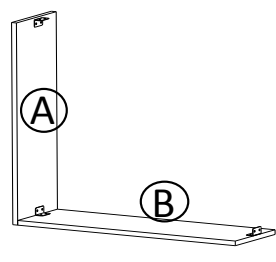

STEP:2

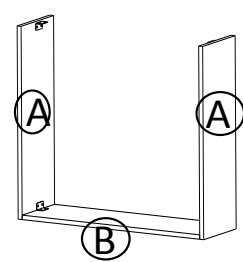

STEP:3

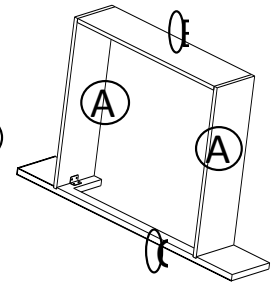

STEP:4

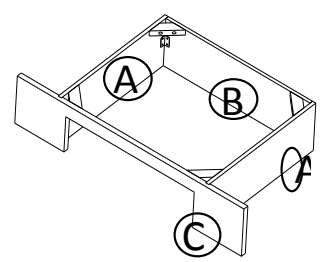

STEP:5

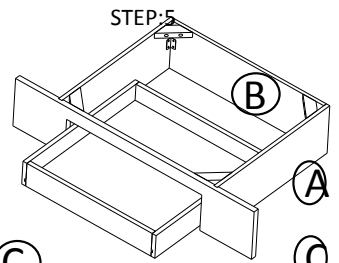

STEP:6

