

W0930,W1230,W1530,W1830,W2130
W0942,W1242,W1542,W1842,W2142

ASSEMBLY INSTUCTIONS

Getting started:

prepare a protection layer, a screwdriver

STEP 1: Joint side panel with back panel

STEP 2: Joint top panel with side panel

STEP 3: Joint bottom panel with side panel

STEP 4: Attach frame on





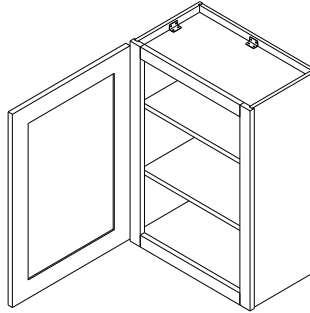

STEP 5: Put on the adjustable shelves

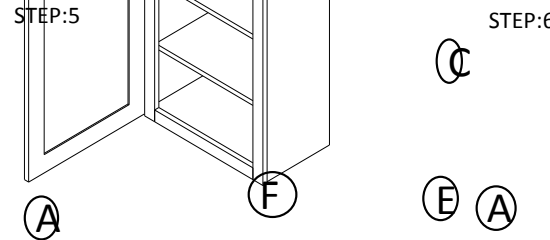
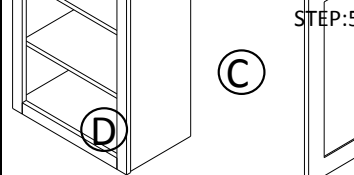
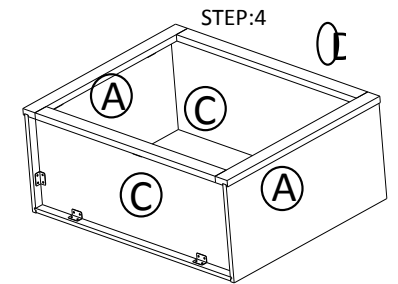
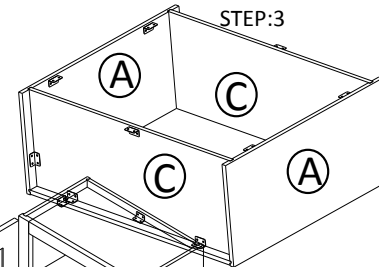
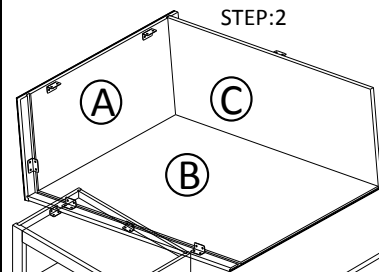
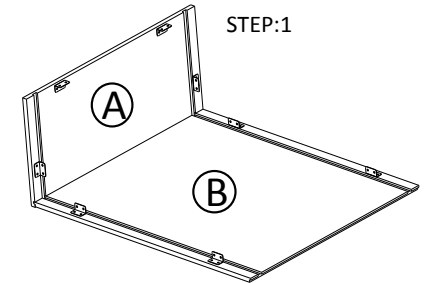
STEP 6: Fix door onto the frame and adjust the cover-space

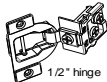

PARTS LIST		
NO.	Description	QTY
A	SIDE PANEL	2
B	BACK PANEL	1
C	TOP&BOTTOM PANEL	2
D	FACE FRAME	1
E	ADJUSTABLE SHELF	2 OR 3
F	CABINETS DOOR	1

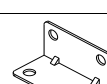

7	1/2" HINGE	2	 1/2" hinge
6	3/4" ROUND HEAD SCREW	2	 3/4" round head screw
5	BUMPER	2	 Bumper
4	SHELF CLIP	8	 Shelf clip
3	9/16" ROUND HEAD SCREW	40	 9/16" round head screw
2	CLEAT	10	 Cleat
1	1" FLAT HEAD SCREW FOR CARCASS	4	 1" flat head screw
NO.	Description	QTY	PICTURE

HARDWARE LIST